

ISS	REVISED BY:	REVISION DATE	ECO #

NOTES:

MATERIAL:
 HEAD & SHACKLE- DUCTILE IRON, 40 KSI YIELD
 RIVET PIN - CARBON STEEL

FINISH:
 HOT DIP GALVANIZED PER ASTM A123

DIMENSIONS: INCHES

MECHANICAL RATING:
 ULTIMATE TENSILE RATING: 16 KIPS
 SOIL BEARING SURFACE AREA: 18.14 IN²

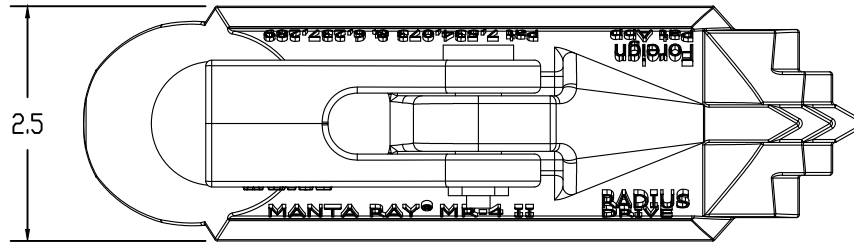

TAPPED TO ACCEPT 3/4-10
 THREADED RODS

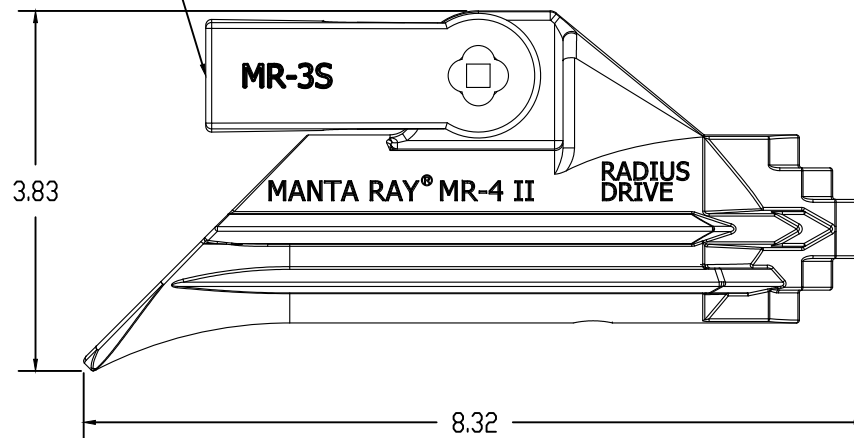

This drawing contains confidential information that is the property of MacLean Power, L.L.C. ("MacLean"). Use of MacLean's confidential information without MacLean's express written consent is strictly prohibited and may expose you to legal liability. If you believe that you received this material in error, please destroy it or return it to MacLean Power, L.L.C., Kingsley Park Five, 481 Munn Rd. Suite 300, Fort Mill, SC 29715, USA.



WWW.MACLEANPOWER.COM

CATALOG NUMBER: MR04GE075R010X		
SHEET NAME: Sheet1	1 OF 1	
DRAWING DESCRIPTION: MR-4-3/4-10G ANCHOR/SHACKLE ASSEMBLY		
DRAWN BY: DH	DATE: 06/21/2021	APPROVED: DR